



ISTANBUL
GELISIM
UNIVERSITY

IGVS

Monthly Press Release

June

2022

Volume 2 / Issue 6

myo.gelisim.edu.tr



The logo of Istanbul Gelisim University has been changed. The current logo of our university is as follows. We present it to the information of our valued readers.



ISTANBUL
GELISIM
UNIVERSITY

Dear Young People,

Istanbul Gelişim Vocational School, which started its education life in 2008, started to publish a monthly E-Bulletin as of 2021. We are very happy to bring you the June issue of our e-bulletin and to share with you the developments in our Vocational School. I believe you will enjoy reading our bulletin and I present my greetings and respect with the hope of meeting you in a new issue.

You can follow all the developments in our Vocational School on our social media channels.

***Director of IGVS
Assist. Prof. İsmail Cem AY***

Facebook:
igumyo



Twitter:
igumyo

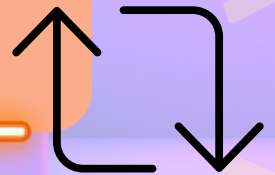

Instagram:
igumyo



ISTANBUL GELISIM UNIVERSITY IS 16TH IN THE WORLD AND 1ST IN TURKEY IN THE FIELD OF "QUALITY EDUCATION"!

Times Higher Education (THE), the ranking institution of world universities, has been announced the Impact Ranking of 2022. Among the 1180 universities in the world, Istanbul Gelisim University (IGU) increased its success ranking, which was 24 last year, to 16th place in the category of "Quality Education" by increasing 8 steps this year. It continued to maintain its success last year, ranking 1st among Turkish universities.

The success of Istanbul Gelisim University (IGU) was ranked in five different categories in line with the United Nations Sustainable Development Goals, in the list of 1406 universities, which are listed in the 2022 ranking of the UK-based, world's leading higher education rating agency, Times Higher Education (THE). In the Impact Ranking 2022 list, Istanbul Gelisim University (IGU) increased its degree from 24th to 16th among 1180 world universities in the "Quality Education" category, while maintaining its 1st place among Turkish universities.

5 ACHIEVEMENTS FROM 5 DIFFERENT CATEGORIES

In the ranking carried out in line with the categories in 17 fields determined by the United Nations within the scope of the Sustainable Development Goals (SDG), Istanbul Gelisim University is among the universities of Turkey, with its studies in the field of education, innovative projects and its contributions to the society;

- SDG4: Ranked 1st in Turkey in the Quality Education category,
- SDG7: Ranked 4th in Turkey in Accessible and Clean Energy category,
- SDG3: Ranked 12th in Turkey in the category of Healthy and Quality Life,
- SDG6: Ranked 12th in Turkey in the category of Clean Water and Sanitation
- SDG17: Ranked 24th in Turkey in the Partnerships for Purposes category, it proved itself in many areas such as lifelong learning practices, community-oriented learning, personal development opportunities, quality and sustainability of the education provided.



“IN THE INTERNATIONAL RANKING, WE HAVE INCREASED OUR SUCCESS 8 STEPS!”

Abdulkadir Gayretli, Chairman of the Board of Trustees of Istanbul Gelisim University (IGU), who made a statement about the ranking in which the effects of ecological, economic and environmental sustainability practices on society according to the United Nations 17 Sustainable Development Goals are aimed, stated that while Istanbul Gelisim University was among the top 100 universities in the "Quality Education" category in the past years but today it is in the 16th place in the world ranking and he said:

“Istanbul Gelisim University has added a new one to its national and international successes with its growing experience and strong tradition over the years. In the 2022 rating of Times Higher Education (THE), one of the most respected higher education rating institutions in the world, we moved up 8 places from our 24th place in the "Quality Education" category in the world ranking, to 16th this year. This rating, which we received from a reputable organization, makes us proud and motivates us for years to come. We are preparing for the future by being open to continuous development for this purpose. By hosting many national and international large-scale projects within our university, we are shaping scientific achievements and the future.”



“WE SUPPORT SUSTAINABLE DEVELOPMENT GOALS”

Stating that they continue to work to achieve better every year with the slogan of "Be Open to Development!" Abdulkadir Gayretli emphasized that 65 programs within the university are accredited by international accreditation institutions and that they will continue to provide education at international standards. Stating that they are the first Turkish university to teach sustainability as a compulsory course, Gayretli said, “Under the leadership of Prof. Dr. Erol Özvar ,The President of the Higher Education Institution (YÖK), we want universities to be leading institutions in raising qualified manpower and creating knowledge and technology accumulation in line with Turkey's development goals, and we support sustainable development goals. We have made education and research our mission for the future of the world and humanity. We continue to work by giving importance to sustainability in order to leave a better world to future generations and to achieve lasting success.”

Times Higher Education (THE), Impact Ranking (Impact Ranking) 2022 list can be found here.



Among the Top 500 Universities Worldwide in the Field of Engineering and Ecological Sciences!



SCIMAGO
INSTITUTIONS
RANKINGS

The Spain-based ranking organization, SCImago (SIR), which ranks the universities from the point of view of the social effect indicators on the basis of their research performances, innovation printouts and web visibilities , announced its ranking list of international universities for 2022. While the Istanbul Gelisim University ranked among the first 500 universities worldwide in the field of Engineering and Ecological Sciences, it succeeded to rank on the 721st best university among 4.364 universities in general ranking.

One of the leading ranking organizations internationally, SCImago (SIR), which evaluated the web visibilities for 2021 of the research and innovation activities of the universities between the years of 2016-2020, published and announced the list of the leading international universities for 2022. While the Istanbul Gelisim University ranked among the top 500 universities within the field of Engineering and Ecological Sciences, it took place on the 721st best university among a total number of 4.364 universities internationally.

On the 24th Rank in the Fields of Economics, Econometrics and Finance

140 universities from Turkey took place in the SCImago 2022 list where the scientific performances of the Universities were evaluated in 19 different fields. While the Istanbul Gelisim University was listed on the 24th rank among the universities in Turkey at the research and innovation printouts, made in the fields of Economics, Econometrics and Finance, it occupied the 33rd rank at the list in the field of Engineering. The IGU, listed on the 16th rank in Turkey at the field of Ecological Sciences, occupied the 58th rank among the Middle Eastern universities and 351st rank, however, among the OECD universities.

[Click](#) to access the SCImago 2022 world university rankings.

8.188 Students Graduated From Istanbul Gelisim University

The 2021-2022 Istanbul Gelisim University graduation ceremony was held for the first time after the pandemic, with all students and their families brought together. During the two-day ceremony, 8,188 students graduated from undergraduate and associate degree programs.



This year's graduation ceremony—the first step for thousands of young people to enter business life—was held for the 13th time. Students from Istanbul Gelisim University graduated with ceremonies held at the Yahya Kemal Beyatli Conference Hall on June 21 and 22, 2022, after finishing their education and training with the knowledge and skills of the 21st century.



IGVS, 2021-2022 Academic Year Graduation Ceremony took place on Wednesday, 22.06.2022 at Yahya Kemal BEYATLI Conference Hall. After the opening speech of IGU Chairman of the Board of Trustees Abdülkadir GAYRETLİ, IGU Rector Prof. Dr. Bahri ŞAHİN and IGVS Director Assist. Prof. Dr. İsmail Cem AY, the programs of our vocational school experienced the enthusiasm of graduation, respectively. We congratulate our graduates and wish them success, health and happiness in the new period of their lives.



OUR ACADEMICS WRITE...

Seeing the Future

Lect. Metin Şahin
Computer Programming Program

Parallel to sending space humans out of the world, one of the biggest goals of scientists is to make a machine that will perform more advanced functions at least like a human. Naturally, the flow of this process and the stages passed are among the requirements of science and technology. This approach, which has been and will continue to be the subject of many science fiction studies, is open to all kinds of thoughts and interpretations of these thoughts in every sense. The "human-robot" war, which is likely to happen one day in the future, which is mentioned very often, is correct on the basis of evaluation with today's approach, but in the future, it will be similar to the approach of countries fighting each other for other reasons or not getting along in the current world.

Because in the future, robots (electronic/electromechanical) will come to the fore more in living life and in the presence of inanimate substances and will be seen as an ordinary natural event (rain, eating, drinking, etc.). Just as a baby is in communication with his mother and father after his birth, this situation will be shaped in terms of communication with robots in the future. In this case, concepts that are far ahead of today's concepts will be in question. Because every time lived and these time periods have an infinite number of values belonging to them. (Even if time travel ceases to be science fiction and becomes science.) However, after the realization of these predictions (seeing the future in this sense), whether living things or robots will prevail will not be of much importance for the next step. Because no matter which side, a return to the beginning "in terms of science and technology" will occur. This situation is not on the basis of thought, but in the sense of whatever comes to mind such as usable tools, equipment, equipment, objects etc. This approach is not only valid for the current Earth, but not for lifelike celestial bodies or other objects discovered up to that time. Because in the near future, after other environments suitable for life (outside the Earth) will be discovered or made suitable for life, it will be as natural for living things and robots to go there as the water takes the shape of the object it is in.



In this case, too, the concept of the international will take on an interplanetary structure, and if it is further, it will take on an inter-universe structure. This will show a development towards “occupations and their division into branches”, which is beyond predictions at the moment. However, in every process of life, there have been living things that are very forward-thinking in science and technology. In this sense, there is a great need for a living thing, at least on Earth, in terms of its thoughts and their implementation. Undoubtedly, it is possible to have supernatural powers here and their involvement. Just as lightning is one of the forces of nature, the same approach is to see the future, which is beyond predictions, on the basis of living things living in nature.



Because the effect of such advanced farsightedness will be just like the effect of a lightning bolt depending on where it hits. (As it can be seen and its effect is felt in a positive or negative sense.) In this way, the plans made for the future will take on different meanings compared to the meanings they already differ in. This situation, in turn, will take a correct form to the luck of the celestial body (on the basis of all living and non-living matter), far more than the chance of the society in which the person in question lives. In addition to providing support, it is also possible to be prevented (to the extent that both can be vital). Because one living thing can be worth billions of living things (in terms of their thoughts and their implementation). (This approach does not mean putting the right to life first.) In addition, living things have the right to exist in nature in non-living matter as much as the right to life. Because, like plus and minus, both (two) types complement each other and are indispensable for each other. An example of this is the approach that a creature with feet has no place to stand, or that a creature with wings has no environment to fly. Because the situation is contrary to the reason for existence

EARTHQUAKE TRUTH

What is an Earthquake and How Does It Occur?

Lect. Bahar YAMAN
Construction Technology Program

Earthquake, also known as seismic movement, ground shaking, is defined as a shaking movement that occurs unexpectedly with fractures in the earth's crust as a result of tectonic events.

Plates moving as a result of tectonic events move away from each other, converge or move relatively along their boundaries. As a result of this movement, stresses occur at the plate boundaries and with this stress, elastic deformation occurs in the plates.

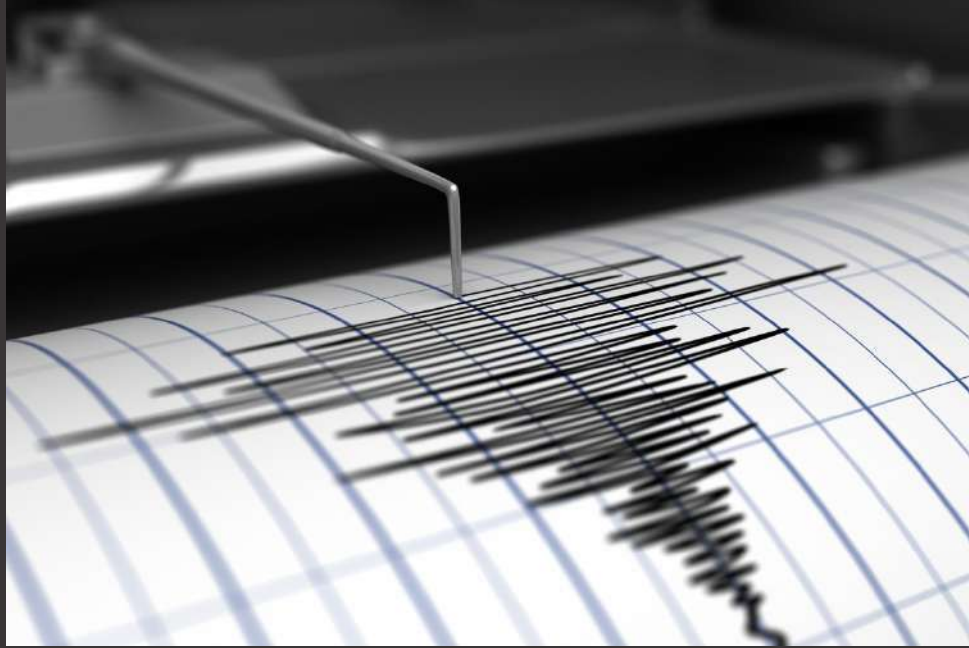

Sheets that deform as a result of elastic deformation also break along their weak surfaces. As a result of elastic deformation in the parts where this breakage is observed, the plates want to return to their original state. As a result of the plates returning to their former positions and breaking, the stress accumulated on the plate is suddenly released. During a stress release, seismic waves occur in the earth's crust. Earthquakes are vibrations created by these seismic waves that occur in the earth's crust.

Seismology is the branch of science that examines the occurrence of earthquakes and all issues related to earthquakes such as intensity, measurement, recording, and waves. The most basic event in seismology is to define the earthquake correctly. Certain earthquake parameters are used to define the earthquake correctly. These parameters are hypocentre, epicentre and depth of focus.

The hypocentre is the point within the earth where energy first appears. It is also known as the focal point. Epicentre is the name given to the closest point where the energy formed in the earth reaches the earth. It is also called external center.

Depth of focus is the distance between the focal point and the epicenter. Knowing the focal depth in earthquakes has an important place in determining the earthquake intensity (the effect resulting from the earthquake).

Millions of earthquakes occur every day in our country and all over the world. Some of these earthquakes can be felt, and some are small energy discharges that are not felt on earth. The reason for these differences in earthquakes is related to the magnitude, intensity and focal depth defined as the earthquake size.

Earthquake Magnitude

Size is a concept that determines the amount of energy released as a result of vibrations. It is not possible to directly measure the energy generated as a result of vibration, shaking motion. In order to eliminate this problem, an instrumental measure, the magnitude, was defined by the American Professor C. Richter in 1930.

Magnitude is defined as the logarithm to base 10 of the maximum amplitude, measured in microns, of the ground motion recorded with a seismograph located 100 km from the epicenter and placed on hard ground (rock).

The instrumental magnitude is obtained with the help of the necessary instrument calibration functions by using the determined special seismograph (the device that records earthquake movements) and the maximum amplitude and period values of the ground motion. It is calculated using volume waves and surface waves.

The magnitude is denoted by M . There are many sizes used by seismographs. These:

- Local size (ML)
- Surface wave magnitude (Ms)
- Moment magnitude (Mw)
- Time dependent magnitude (Md)
- Object wave size (Mb)
- Moment magnitude is the most commonly used one to determine the amount of energy released during an earthquake.



Earthquake Intensity

It is the oldest method used to determine earthquake size. Violence is a concept used to describe the effect of ground motion on people and the extent to which structures are damaged as a result of this effect.

The concept of violence was formed before the advent of modern seismic devices. It has been used to estimate the location and size of historical earthquakes.

The intensity scale is used to characterize the earthquake intensity. The main severity scales used today are listed below. Modified Mercalli Severity Scale, one of these severity scales, is widely used today.

Modified Mercalli Severity Scale (MMI)

Rossi - Forel Severity Scale (RF)

Japan Meteorological Agency's Severity Scale (JMA)

Medvedev – Spoonhever - Karnik Severity Scale (MSK)



Awareness

Considering the earthquake definition and the information about the earthquake, earthquake is an unstoppable reality for today. In this case, the first question that comes to mind is, "How should we create awareness in this reality and how should we minimize the damage that may occur?" will be.

The first awareness that can be created against earthquakes is that we cannot stop it worldwide with our current technology. In this case, it is necessary to be resistant to the force effect from the earthquake in any case. We should realize this durability mostly in structures that we design as permanent or long-lasting. This situation has become a little easier with the detailed information obtained against earthquakes, the developed earthquake regulations and earthquake dampening isolators.

We should not forget that it is in our hands to minimize the damage that an earthquake can cause, which is an unchangeable fact.

Remember; Earthquakes cannot be prevented, but earthquakes can be prevented from turning into disasters!!



Bibliography:

Yıldırım, M. ve Gökaşan, E. (2013). "Mühendisler için Jeoloji Bilgileri", Genişletilmiş İkinci Baskı, İstanbul.

Kramer, S. L., "Geotechnical Earthquake Engineering", Prentice Hall, New Jersey; Çeviren: Kayabalı, K., "Geoteknik Deprem Mühendisliği", Gazi Kitabevi, Temmuz 2003.

Day, R. W., "Geotechnical Earthquake Engineering Manual", McGraw-Hill; Çeviren: Mollamahmutoğlu, M. ve Kayabalı, K., "Geoteknik Deprem Mühendisliği El Kitabı", Gazi Kitabevi, Temmuz 2014.

Afet ve Acil Durum Yönetimi Başkanlığı, Türkiye Bina Deprem Yönetmeliği, "<https://www.afad.gov.tr/depremler-onlenemez-ancak-depremlerin-afetlere-donusmesi-onlenebilir>", 12 Haziran 2022.

Türkiye Bina Deprem Yönetmeliği, <https://www.resmigazete.gov.tr/eskiler/2018/03/20180318M1-2.htm> 12 Haziran 2022.

Translohr Rail System

Lect. Bilge Yilmaz
Engine Program

The use and importance of rail systems all over the world is increasing day by day. Light rail alternative solutions can come to the fore, especially in urban public transportation systems.

Of course, when it comes to alternative light rail systems, rubber-tired, guide rail systems developed by TransLohr company draw attention.

Since the wheels that provide the main movement on the trams with the system, which is a patented product of this TransLohr company, are rubber wheels, it is actually not different from an articulated bus when viewed from the outside.

The main difference from a bus, or even from all vehicles with rubber wheels, is that the steering system is not made on the steering wheel. The steering task is carried out with a single guide rail, not double, as in rail system vehicles.

At the same time, this guide rail system completes the electrical line from the catenary line.



The biggest factors in the emergence of this alternative light rail system are of course the advantages of the rubber wheel. These include being able to climb steeper slopes, lower turning radius, reduced infrastructure and maintenance costs, and braking distance.

It creates an alternative as an environmentally friendly and low-cost public transportation vehicle, especially since infrastructure formation can be fast and easy.

References:

<https://en.wikipedia.org/wiki/Translohr>

<http://www.newtl.com/en/translohr/>

<https://stringfixer.com/tr/Translohr>

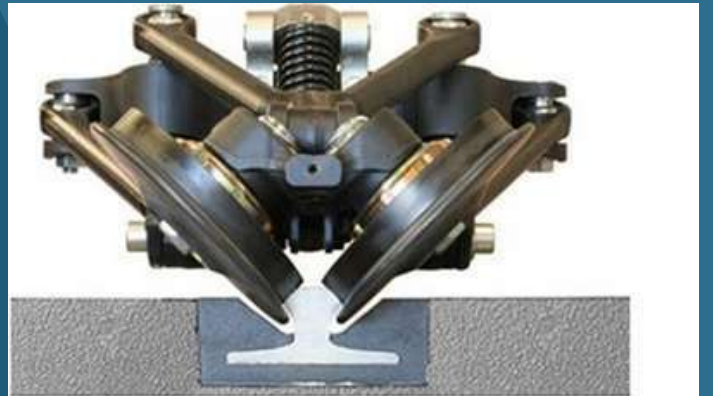

Source : Lohr Industrie



Members of the Liberty and Justice Club “Makes being human superior to all other elements, regardless of language, religion, race.”

Liberty and Justice Club members will be included in a community where they can express themselves, present their ideas, put forward their thoughts and find the opportunity to develop themselves, as well as their school life. Our club will try to bring perspective to individuals with an understanding that considers law, equality, ethical approach, rational analysis and fairness. As club members, we will also carry out activities that bring social segments together through various activities including unity, solidarity and social assistance activities. Members of the Liberty and Justice Club will aim to direct the person on conscience and fairness and will work towards this.

During the year,

- Touristic itineraries,
- Talk shows,
- Book campaigns,
- Salon programs
- Interview programs with legal experts,
- Seminars and interviews on the agenda,
- Courthouse and law office tours,
- Visits to child welfare institutions,
- Nursing home visits,



We aim to learn new information in the field of law, which will benefit humanity in the social sense and contribute to the personality development of students with activities such as.

OUR EVENTS

The "Tips for an Effective Job Interview" event was held, organized by Istanbul Gelisim University, Istanbul Gelisim Vocational School Human Resources and Career Club.

At the event held in the conference hall of our Vocational School, where Human Resources Director Serkan ÖZKAYA was a guest, Human Resources Managers were asked "Where does Recruitment Start, What is the Importance of Roles, What is Competence, Where are the Sources for Finding Candidates?" and by the candidate, "What are the Points Candidates Should Consider in Interviews, What Are the Tips for Effective Interviewing?" information and experience were shared on the topics.

After our students' questions were answered, our event ended with a plaque presentation.



Effective Employability Skills Job Club Training was organized jointly with İŞKUR.

Effective Employability Skills Work Club Training, which was organized jointly with İŞKUR between 12:30-15:00 within the scope of Entrepreneurship course, on Monday, 16.05.2022 in the classroom no. G Block 317, was concluded successfully.

In this in-class event organized by Instructor Emine ÖZTÜRK from the IGVS Logistics program and Instructor Adnan Kürşat TEKE, one of the academicians of Computer Programming, with Information Security Technology students, Job and Vocational Counselors Gülay KANOĞLU and Oktay DURAN provided information about the İşkur system's job search, personnel search departments,



on-the-job training programs and job acquisition courses in the first session. In the second session, they gave practical suggestions on how companies can be affected by effective CV techniques. In the third session, a survival on the Moon competition was held to develop individual and team business planning skills. Congratulations to our first Teletubbies team.

The event, which was carried out with the enthusiasm and high energy of the students, ended with the presentation of thanks and gifts to the participants.

BAPUM, TTO and TEKMER Units Met in Our Vocational School.



An Information Seminar on Project Development, Patent Process and Incubation Center was held in cooperation with BAPUM, TTO and TEKMER units of our university in cooperation with BAPUM, TTO and TEKMER at the G Block Aziz Sancar Conference Hall on 26.05.2022 between 14:00-17:00, organized by Logistics Program academics Emine ÖZTÜRK and Computer Programming Program Head Lecturer Adnan Kürşat TEKE. Faculty Member Serap YEŞİLKIR BAYDAR from BAPUM unit, Researcher Ali ÇETİNKAYA from TTO unit, Researcher Muhammed Ömer ERDOĞAN and Lecturer Çağrı FAYDACI from TEKMER unit attended our event as speakers. The event took place in 3 sessions, in which Lecturer Emine ÖZTÜRK introduced the operation of each unit, the support process, and answered student questions. The event ended after the speakers were presented their plaques.

Within the scope of the Civil Aviation Cabin Services (English) and Civil Air Transport Management programs, a Conversation event on the Aviation Sector was held on Tuesday, May 24, at 16.00 in classroom 304.

Students from the Civil Aviation Cabin Services (English), Civil Air Transport Management, Civil Aviation Cabin Services (Turkish) and Flight Operations Management programs attended the event.

In the interview with the participation of İGA Airport Operations Inc., Airside Operations Chief Tolga Han Özgür and İGA Airside Operations Assistant Specialist İlhan Semih Keleş, the students were informed about the air operations processes.



An event called School and Vertical Transfer Exam Process was held at 10:00 on Tuesday, May 24, 2022, within the İGMYO Computer Technologies Department. Our DGS candidate students, who participated in the event held in the classroom G Block 318, attended by our 2021 DGS 500th ex-student Betül ÇAPAR, gained useful information about the school and the DGS process. With this event, it is aimed to give information to our DGS candidate students, especially in their 2nd year, on how they can successfully carry out school lessons and DGS preparation together.

An event on the Place of Artificial Intelligence and Machine Learning Studies in the Industry was held on Tuesday, April 19, 2022, at 12:00, within the IGVS Computer Technologies Department. Our former student Harun Berkin ÇETİN, who has worked on Artificial Intelligence and Machine Learning in many domestic projects, also participated. Our students participated in our event held in the G Blok Prof. Dr. Aziz Sancar Conference Hall, and by making initial touches about Artificial Intelligence studies and Machine Learning, useful information about this process was obtained. With this event, it is aimed to inform our students at our university about how Artificial Intelligence is used in the sector and the importance of Machine Learning for this purpose.



An event on Data Science and Analysis was held at 15.00 on Tuesday, May 24, 2022, within the IGVS Computer Technologies Department. Our former student Nefise KOÇER, who worked as a data analyst in countries such as the Netherlands and Bulgaria and took part in many domestic and international projects, participated in our event, which was held in the G Blok Prof. Dr. Aziz Sancar Conference Hall, and our students gained useful information about Data Science. With this activity, it is aimed to give information to our students at our university about questions such as how to do Data Analysis and where to start.

An event called Artificial Intelligence and Iris was held at 15:00 on Wednesday, May 25, 2022, within the IGVS Computer Technologies Department. In our event, which was held at the G Blok Prof. Dr. Aziz Sancar Conference Hall, in which our student Ali Eren Kaya, who won the 2nd place in the 2022 Robotex competition, and his teammates participated, useful information was obtained about the students' motivation to produce projects, prepare for the competition and work for the degree. With this training, it is aimed to give information to our students at our university about producing projects at the level of obtaining patents, marketing the product, finding sponsors, and generating income by working with sponsors.



An event on the Importance of 14 March Pi Day was held within the IGVS Computer Technologies Department. In our event, which was held on Monday, March 14, 2022 at 14:00 and attended by Assist. Prof. Kadir MERSİN, one of the academicians of our university, useful information was obtained about the place and importance of mathematics in life. With this activity, it is aimed to give information about the place of Mathematics in life by organizing an entertaining activity for our students at our university in order to break their prejudices about Mathematics.

The SEO techniques training, organized by Lect. Çisem Yaşar and Lect. Tuğba Saray Çetinkaya, academicians of IGVS, Computer Technologies Department, with the participation of SEOCU.COM SEO Agency, was held. Basic SEO techniques and practices were conveyed to the participants in 4 sessions by SEO expert and agency manager Volkan Sucu.

What is SEO?

The word SEO consists of the initials of the phrase “Search Engine Optimization”. Its Turkish equivalent is expressed as “arama motoru optimizasyonu”. If we examine the SEO work; As the name suggests, we can describe it as a study that makes internet projects suitable for search engines with certain rules and thus ensures that the sites rise to the top in search engines.

Source: <https://www.seocu.com/seo>

Purpose and Benefits of SEO Training

The main purpose of our education; To understand the subject of SEO (search engine optimization), which is a method of reaching large audiences in the digitalized world, and to learn the methods of getting to the top in search engines. Students who receive SEO techniques training will have information about the working principle of search engines and the optimization of websites. After the education, students who are interested can specialize in this sector by improving themselves in this field.



The training provided information on the following topics:

- What is SEO?
- Purpose of SEO
- Working Principle of Search Engines
- On-Site Optimizations
- User Experience (UX)
- Off-Page Optimizations
- SEO Tools
- Applied Studies

Özen ÖZER and Onur Alp ÜLKER from Ozstech Information Security were guests of the event called Security Operation Center and Cyber Defense, organized by Lect. Çisem Yaşar and Lect. Tuğba Saray Çetinkaya, academicians of IGVS, Computer Technologies Department. In the event, SIEM training was given in order to start the sector one step ahead.



The event provided information on the following topics:

- Motivational speech
- What are the differences between Blue, Red, Purple teams?
- What should be considered when creating the security architecture?
- What is IDS?
- What is IPS?
- What are the main differences between IDS and IPS?
- What is DLP?
- What is the purpose of DLP installation and what does it aim for?
- What is SIEM?
- What is NBAD?

A concept design exhibition with the theme "Year 2100" was organized within IGVS, Computer Aided Design and Animation Program. Students who took the Computer Aided Design-II course participated in the exhibition prepared by Lect. Hasan AKTAŞ.



NEWS FROM IGVS



The article titled "Investigation of electrical and electromagnetic properties of quartz fiber reinforced polymer composite material by using modified paints with carbon nanoparticles (graphene/ double-walled carbon nanotube)" prepared by IGVS Aircraft Technology Program Lecturer Nihal GÜL and her consultant, was published in the "Journal Composite Materials".

<https://journals.sagepub.com/doi/10.1177/00219983221099332>



The article titled "Information Technologies in Translation in Applied English Translation Programs" by Tuğçe APAYDIN AZMAN, IGVS Applied English and Translation Program Lecturer, was published in the RumeliDE Journal of Language and Literature Studies. The access link is below.

<https://dergipark.org.tr/en/download/article-file/2385283>

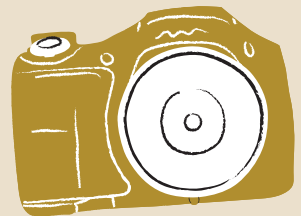



The article titled "A Critical Perspective Reception Study on the Reception of LGBTI+ Individuals in Newspapers" written by Lect. Cihan Emre Tanç at Istanbul Gelisim Vocational School, Photography and Cameraman Program, was included in the book titled "Reception Gender from the Perspective of Cultural Studies" published by Kriter Publishing.



IGVS Foreign Trade Program Lecturer Esat Daşdemir's single-author article titled "A New Proposal for Consumer Price Index (CPI) Calculations and Income Distribution Measurement by Income Groups" was published in the Journal of Economy Culture and Society, which was scanned in ESCI. In addition, a different CPI series was created for each income group, the inflation rates faced by the income groups were calculated and these series were shared.

DOI Number of Article:

<https://doi.org/10.26650/JECS2021-984480>

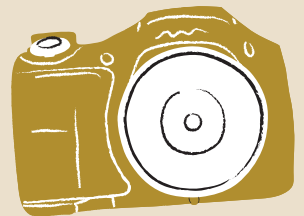



Applied English Translation Program Lect. Tuğçe ÖZDİNÇ presented her paper titled "A Crimson Jane: Intertextuality of The Crimson Petal and the White and Jane Eyre" at the "Yeditepe University Graduate Conference of Literary Studies: "Rethinking / Reapproaching The Home" held on June 10, 2022.

In her paper, ÖZDİNÇ analyzed the differences between Michel Faber's 2002 Neo-Victorian novel "The Crimson Petal and the White" and Charlotte Brontë's 1847 Victorian novel Jane Eyre. ÖZDİNÇ, in her analysis, stated that although Faber's novel is labeled as a rewriting of Jane Eyre by some critics, there is no one-to-one parallelism between the plot or the main characters in the novel, and since the author has no claim that such is the case, it does not fall into the category of rewriting/retelling, and she stated that the novel, The Crimson Petal, bears traces of Julia Kristeva's term "intertextuality".

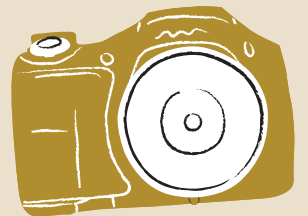



The lecturer from the department of Applied Russian Translation Dr Sevda POLAT participated in the online conference "The world of Russian language and culture in the field of information technology" organized by Moscow State University together with the Language Center on 27.05.2022. Scientists from the universities of many countries such as Russia, Turkey, China, Tajikistan, Kazaxstan, Egypt etc. joined the conference. As a member of the conference organizing committee, Dr Sevda POLAT was one of the keynote speakers. She gave information about the "Development of the Russian Language in Turkey" and stated that the Russian language is among the first languages preferred as a foreign language in Turkey.

In the second part of the session, POLAT presented her paper entitled "Словообразование, как метод изучения новой лексики на уроках РКИ: на примере отглагольных существительных (турецкая аудитория)", "Word formation as a method of learning new words in Russian as a foreign language: in the example of nouns made up of verbs (for Turkish students)".



The article titled "Share of Renewable Energy as Factors Affecting Economic Growth and Foreign Trade Balance" by Duygu ÇELİK, IGVS, Department of Banking and Insurance, was published in the journal of Kent Akademisi. The link to the article is below.

<https://dergipark.org.tr/en/pub/kent/issue/70290/10941>
16

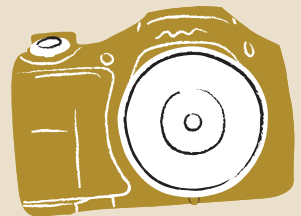



IGVS, Public Relations and Publicity Program Lect. Zeynep ÖZCAN presented her paper titled "Analysis of Luxury Element Presentations in Social Media Phenomenon Sharing as Opinion Leaders: The Example of Instagram" at the Yeni Yüzyıl University Communication Congress held between 9-10 June 2022.



IGVS, Construction Technology Program Lect. Muhammet CEYLAN, one of the authors of the paper titled "Progress on the Assessment of Buried Pipeline Response to Ground Displacements", presented at the Congress of Professor Erol Guler which was held at Boğaziçi University between 22-23 June 2022 in Honor of "Innovative Solutions for Geotechnical Problems".

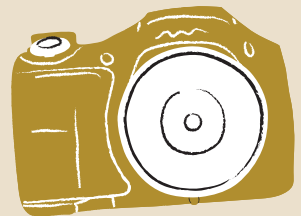



AGENDA OF PERSONNEL

As of 30.05.2022, Lect. Kübra ERDOĞAN has been appointed to the Mechatronics Program of Istanbul Gelisim Vocational School, as the Head of the Program.

Lect. Muhammed Furkan ALTUNPAK has been appointed to the "Lecturer" staff of Istanbul Gelisim Vocational School, Hybrid and Electric Vehicles Technology Program of our university.



MASTHEAD

COORDINATOR

Lect. Görkem Gülay DOĞAN ATICI

TRANSLATION COORDINATOR

Assist. Prof. Dr. Duygu ÇELİK
Lect. Ahmet Burak TURGUT

GRAPHIC DESIGN

Lect. Zeynep ÖZCAN
Lect. Furkan GÖZELCE

SOCIAL MEDIA SPECIALIST

Lect. Hatice SARIYAR

ADDRESS

Cihangir, Şehit Jandarma Komando, J.
Kom. Er Hakan Öner St. No: 1, 34310
Avcılar/İstanbul



PROTECTION AGAINST VIRUS IS IN OUR HANDS



THE MOUTH AND NOSE SHOULD BE CLOSED WITH PAPER TOWEL DURING COUGHING AND SNEEZE. IF YOU DO NOT HAVE ANY WIPE, THE INSIDE OF THE ELBOW SHOULD BE USED.



CLOSE CONTACT SHOULD AVOID LIKE HANDSHAKE AND HUGGING.



IT SHOULD BE STAYED AWAY FROM CROWDED ENVIRONMENTS.



DO NOT TOUCH THE MOUTH, NOSE AND EYES WITH DIRTY HANDS.



HANDS MUST BE WASHED WITH WATER AND NORMAL SOAP FOR AT LEAST 20 SECONDS.



ALCOHOL CONTENT HAND ANTISEPTICS SHOULD BE USED IN CASE OF THERE IS NO WATER AND SOAP.

/SaglikBakanligi

saglik.gov.tr

For Detailed Information,
Please Read QR Code.



www.gelisim.edu.tr

THINGS TO KNOW

All necessary measures are taken for the **coronavirus** revealed in Turkey and the World at **Istanbul Gelisim University**. **Things to know about coronavirus are as follows:**

What are the new coronavirus symptoms?

- The most common symptoms are **fever, cough and respiratory distress**.
- In severe cases, **pneumonia, severe respiratory failure, kidney failure and death** may occur
- Incubation period is between **2 and 14 days**.

How is the virus transmitted?

- It can be transmitted by the contact of the droplets caused by **coughing and sneezing** with the contact of the **mouth, nose and eyes** of other individuals in certain environment and by touching the surfaces where the droplets adhere and taking hands **into the mouth, nose or eyes**.

What to do to be protected from the virus?

- When **coughing or sneezing**, the mouth and nose should be covered with a **disposable tissue**, if there is no handkerchief, the mouth should be closed with the **upper sleeve or elbow**, not with the palms.
- **Handshaking and hugging** should be avoided.
- **Mouth, nose and eyes** should not be touched with dirty hands.
- Hands must be washed for **at least 20 seconds** in accordance with the **Handwashing Instructions** found in the toilets. In the absence of water and soap, **alcohol-containing hand antiseptics** should be used. **Cologne of 70-80 degrees** also serve as disinfectants.
- Offices and classrooms must be **ventilated hourly**.
- Places frequently used by many people such as common areas and door handles should be **disinfected every 2 hours**.
- Hands **must be washed** after using **public transportation**.
- Because the virus progresses faster in people with low immune system; **a balanced and healthy diet** is required. Foods **must be washed thoroughly** before consumption.

What to do if there are symptoms?

- If you have come from countries with infections **in the past 14 days**, apply to the **nearest healthcare facility** by wearing a **surgical mask**.
- If you are **coughing, have a fever and have difficulty at breathing**, apply to the **nearest healthcare facility** by wearing a **surgical mask**.
- **Always wear your mask** when you are in the same room with **a person who is recommended insulation** at home.

